



AGÊNCIA NACIONAL
DE INOVAÇÃO

SYNERGIES OF PROJECTS AND FUNDS

A Perspective from a National Innovation Agency

Lisbon | 03 February'17

José Carlos Caldeira
ANI - President
jcaldeira@ani.pt

FUNDING AND FINANCING

**INCREASE OF TECHNOLOGY DEVELOPMENT SPEED AND DIVERSIFICATION +
PRODUCT AND SERVICE LIFECYCLE REDUCTION = HIGHER PRESSURE FOR
R&D&I INVESTMENT (volume and ROI)**

- **Need to take advantage of all funding opportunities (international, national and regional)**
- **Need to combine and integrate complementary funding sources to cover the entire innovation cycle (different rules, time windows, etc.)**
- **One of the main challenges at European level**

KEY ENABLING TECHNOLOGIES: A VALUE CHAIN PYRAMID

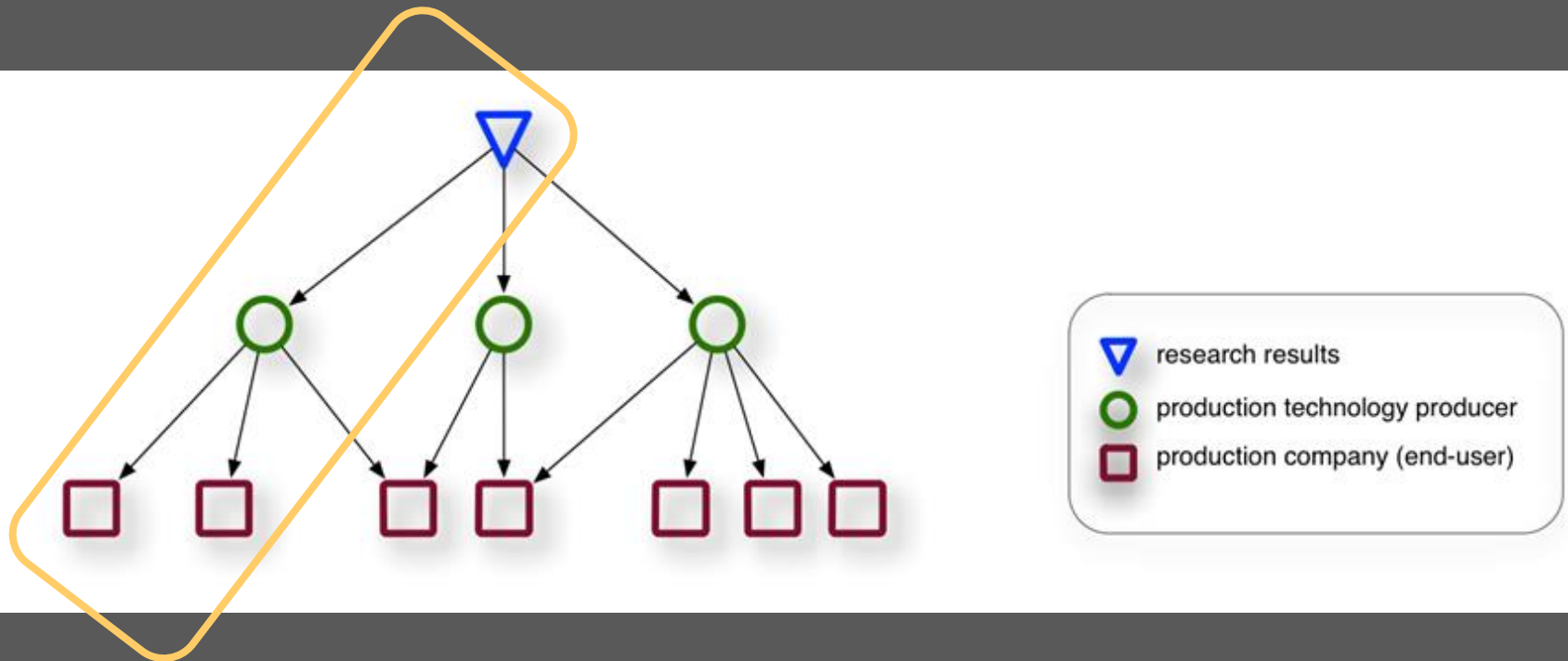

KEY ENABLING TECHNOLOGIES: A VALUE CHAIN PYRAMID

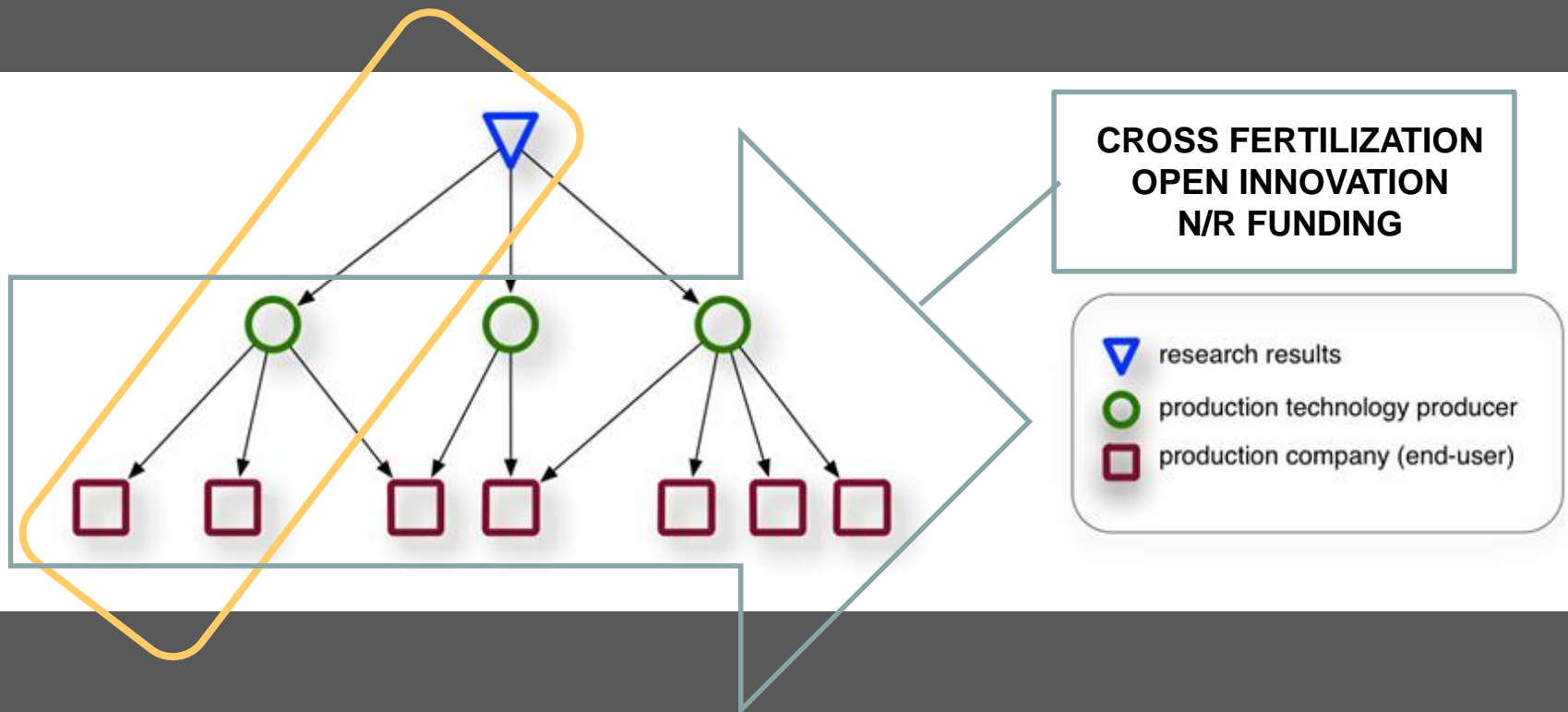

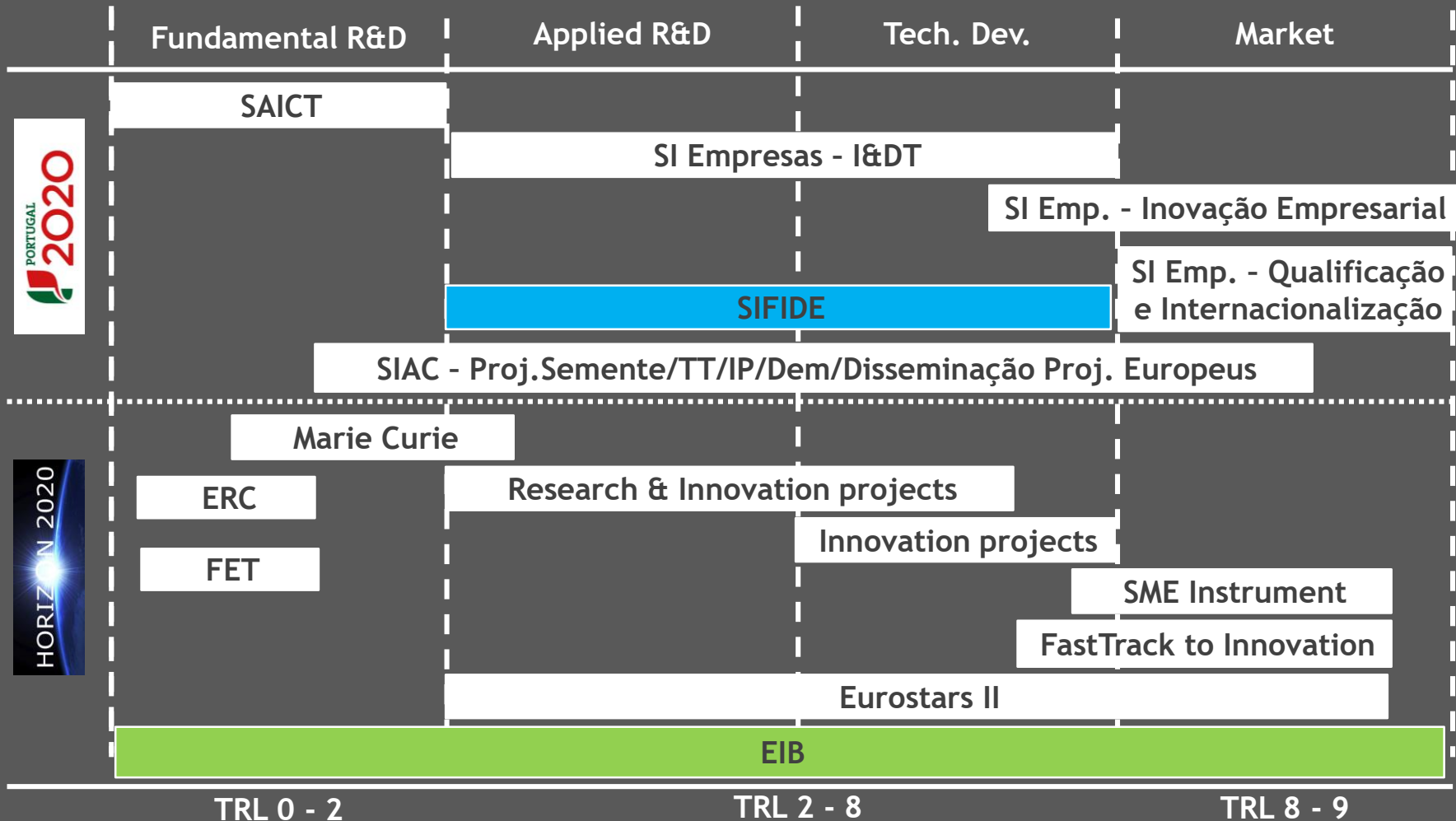

Incentive Systems for companies (Areas)	Project Typologies	Contract
Research and Technological Development (R&TD)	Companies – R&TD	<u>Consortium/Individual</u>
	Pilots and Demonstrators (new)	<u>Consortium/Individual</u>
	Large scale mobilizing projects	<u>Consortium</u>
	R&TD Teams in enterprises	<u>Consortium/Individual</u>
	Protection of intellectual and industrial property (new)	<u>Consortium/Individual</u>
	R&TD Internationalisation (new)	<u>Consortium/Individual</u>
	R&TD Voucher (new)	
Entrepreneurship and Business Innovation	Productive innovation for non-PME's	
	Productive innovation for PME's	
	Qualified and creative Entrepreneurship	
	Entrepreneurship Voucher	
Qualification and Internationalisation of SMEs	Internationalisation of SMEs	
	Qualification of SMEs	
	Internationalisation and Innovation Vouchers	

MICROGRIDS (EU Project)

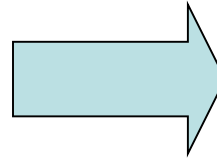
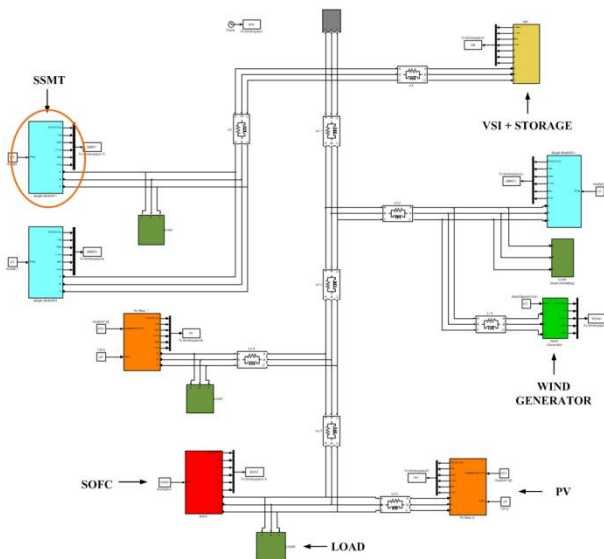

National Project (Pilot > 33.000 consumers)

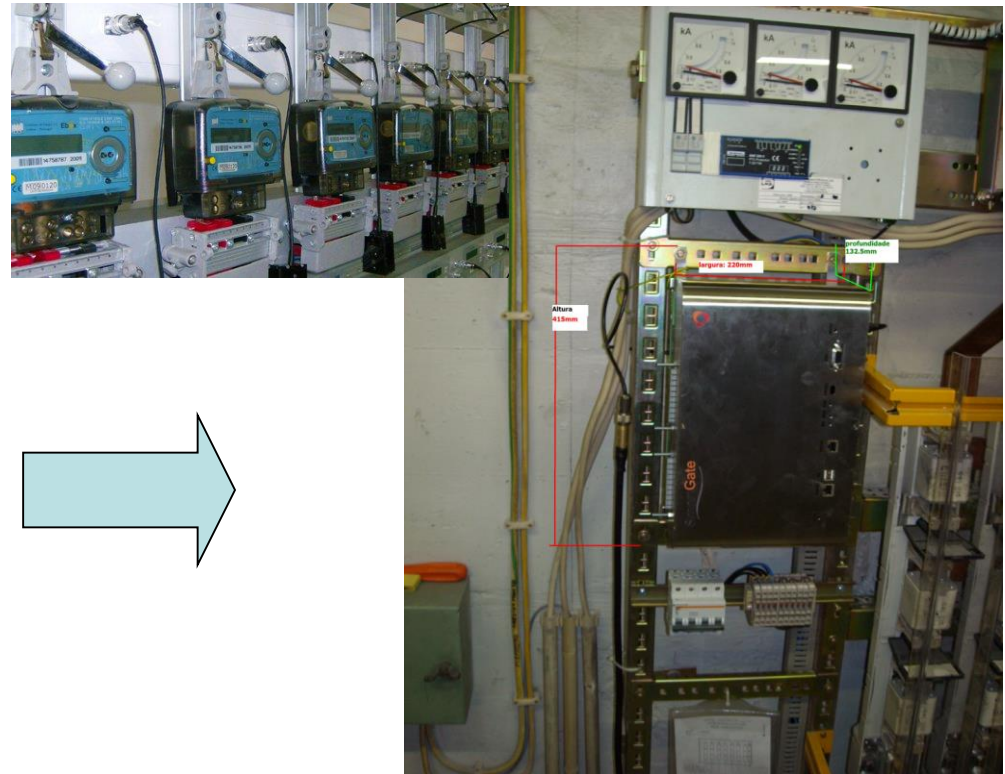
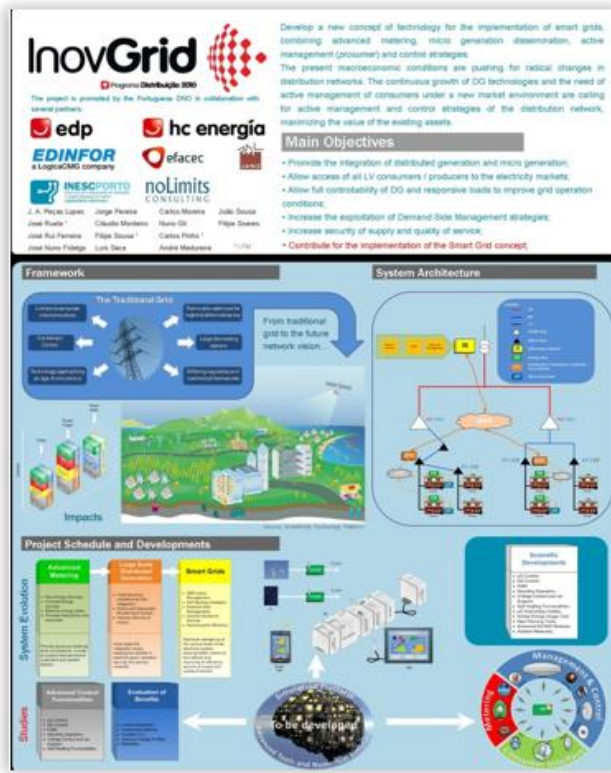

KNOWLEDGE & COLLABORATIVE INNOVATION: Opportunities towards the 2020 milestone Integrated approach to the R&I cycle

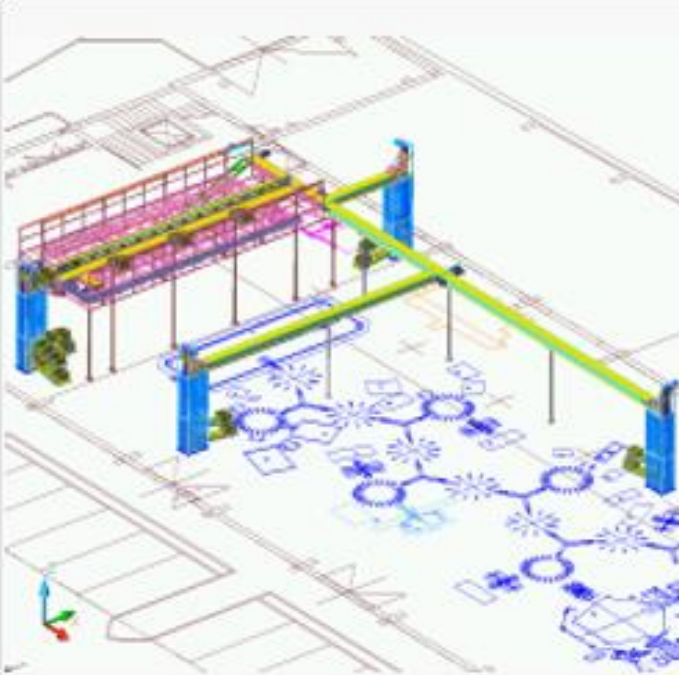

IPP Pilot Plant
Shoe Sector
Vigevano – Italy
Funded by National Funds



Cross Fertilization
Metalworking Sector (Company)
Demonstrator
Porto – Portugal
Funded with Structural Funds





AGÊNCIA NACIONAL
DE INOVAÇÃO

Thank you!

José Carlos Caldeira

jcaldeira@ani.pt